



## Quadro Vino

Design e tecnologia si fondono per dar vita al primo quadro refrigerato mai realizzato al mondo. Un oggetto assolutamente innovativo, dal design raffinato, capace di rendere speciale ogni ambiente in cui è inserito.

*Design and technology combined to create the first refrigerated frame in the world. A greatly innovative article with sophisticated design that will make any location special.*

*Design et technologie ensemble pour créer le premier cadre réfrigéré jamais réalisé dans le monde. Un objet absolument innovant, design sophistiqué, capable de rendre spécial tout environnement dans lequel il est inséré.*



## Quadro Vino

QV40. Struttura bianca, pannello HPL bianco, cornice in colore RAL5012 (light blue).

*QV40. White structure, white HPL panel, frame in RAL5012 finish (light blue).*

*QV40 avec structure blanche, panneau en HPL blanc, cadre en couleur RAL5012 (bleu clair).*

# I modelli

Models • Modèles



QV12



QV30



QV40



QV52

## COLORS (Pag. 170)

CORNICI • FRAMES • CADRES



PANNELLI • PANELS • PANNEAUX

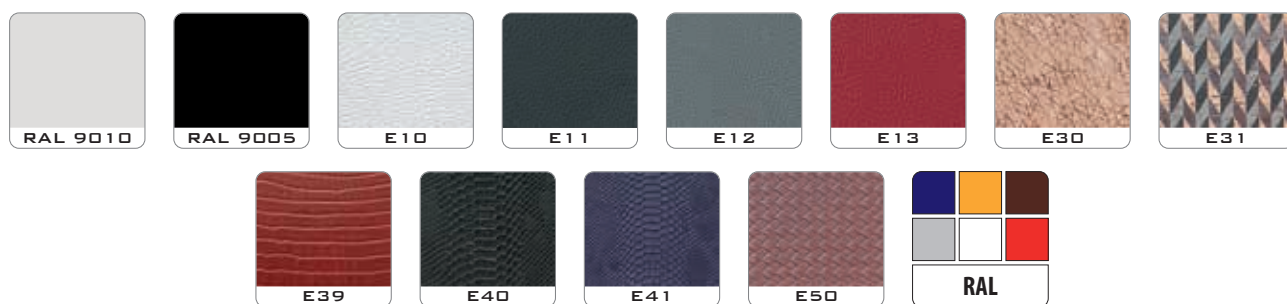





Quadro Vino n. 12

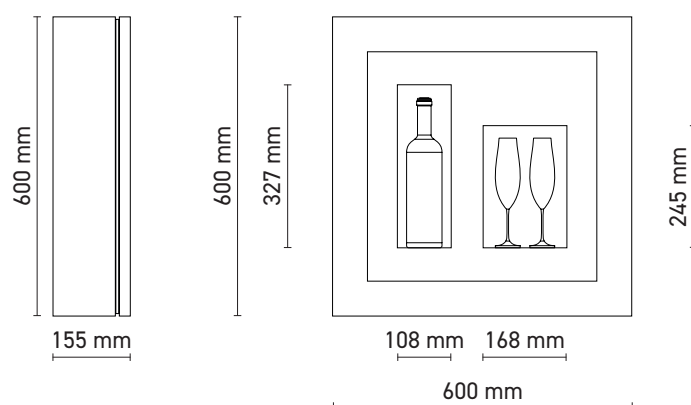

+ 4 / +10

Il QV12 è un espositore refrigerato per una bottiglia e due bicchieri.

La minima profondità e l'installazione a parete ne consentono l'inserimento anche in spazi molto ridotti. È un oggetto studiato principalmente per la camera hotel ma straordinario in qualsiasi ambiente.

Un'atmosfera unica e nuova che invita ad un brindisi veramente speciale.

*QV12 is a refrigerated display for one bottle and two glasses.*

*Its reduced depth and wall installation make it suited even for small spaces.*

*It is mainly designed for hotel rooms but extraordinary in any setting.*

*A unique and new atmosphere that really calls for a very special toast.*

*Le QV12 est un présentoir réfrigéré pour une bouteille et deux verres.*

*La profondeur réduite et la pose murale permettent de l'installer dans des lieux très réduits. Il est un objet conçu principalement pour la chambre d'hôtel, mais extraordinaire dans toutes les ambiances.*

*Une atmosphère nouvelle et unique qui vous invite à porter un toast très spécial.*



Quadro Vino n. 30

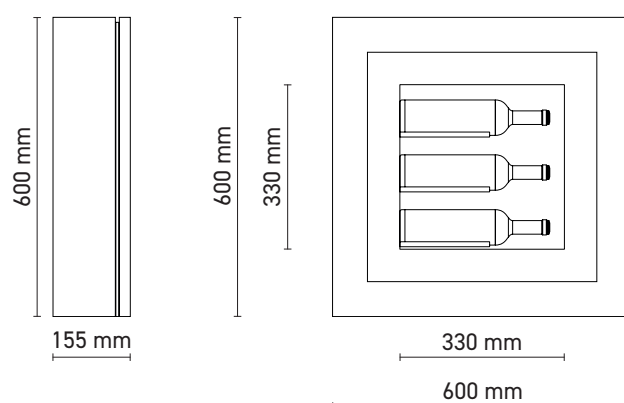

+ 8 / +20

Il QV30 permette di esporre 3 bottiglie di spumante e mantenerle a giusta temperatura di servizio. Su questo modello è possibile scegliere l'opzione dell'esposizione in verticale delle bottiglie ideale per un servizio al bicchiere.

*QV30 allows you to display 3 bottles of sparkling wine and keep them at the right temperature. This model features a vertical bottle display option, ideal for service by the glass.*

*Le QV30 vous permet d'exposer 3 bouteilles de vin mousseux et de les garder à la bonne température. Sur ce modèle, il est possible choisir l'option de l'exposition des bouteilles en vertical, idéal pour le service au verre.*





Quadro Vino n. 40





QV40

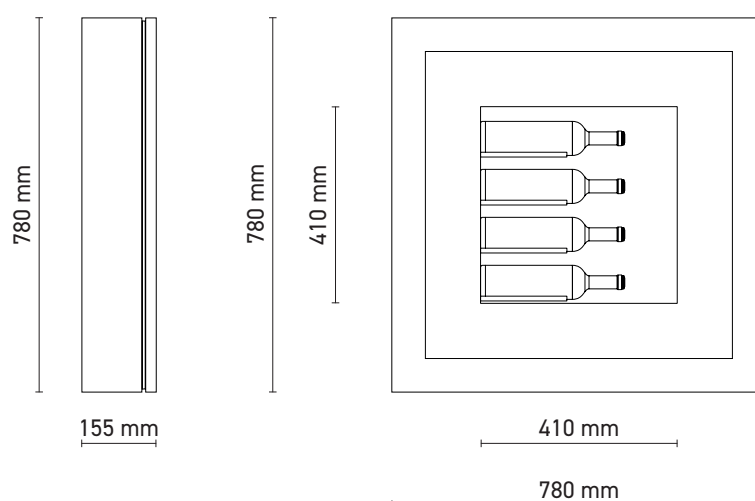

+ 12 / +20

Il QV 40 è un oggetto assolutamente innovativo, dal design raffinato, capace di rendere speciale qualsiasi ambiente. Trova facile inserimento nel ristorante e nell'hotel ma anche nelle residenze private. Su questo modello è possibile scegliere l'opzione dell'esposizione in verticale delle bottiglie ideale per un servizio al bicchiere.

*QV40 is an innovative article with a sophisticated design which will make any setting special. It is suited for restaurants, hotels, and private homes alike. This model features a vertical bottle display option, ideal for service by the glass.*

*Le QV40 est un objet totalement nouveau, design raffiné, capable de rendre tout ambiance spécial. Peut être installé dans le restaurant, l'hôtel ainsi que dans des résidences privées. Sur ce modèle, vous pouvez choisir l'option d'exposition des bouteilles en vertical, idéale pour le service vin au verre.*



Quadro Vino n. 52



QV52

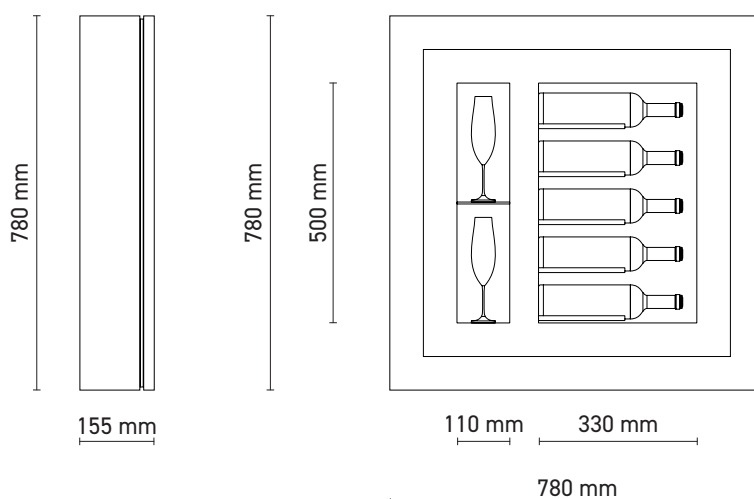

+ 12 / +20

Il QV52 è un espositore climatizzato per cinque bottiglie e due bicchieri, un nuovo modo di esporre, conservare e servire il vino.

Aprire un quadro, prendere una bottiglia di vino e servirla ad una temperatura di 16 °C è un'azione assolutamente nuova che non avremmo mai pensato possibile.

È uno speciale complemento d'arredo che, inserito in cucina o nel salotto, piuttosto che nella sala di un ristorante o di un hotel, non può passare inosservato.

*QV52 is a refrigerated display for five bottles and two glasses: a new way to display, store and serve wine.*

*Opening the frame, taking out a bottle of wine and serving it at a temperature of 16 °C is something we could have never imagined before.*

*A special element that – added to your kitchen and living room, or the dining room of a restaurant or a hotel – cannot go unnoticed.*

*Le QV52 est une vitrine réfrigérée pour cinq bouteilles et deux verres, une nouvelle façon d'exposer, stocker et servir le vin.*

*Ouvrir un cadre du tableau, prendre une bouteille de vin et le servir à une température de 16 °C est une action totalement nouvelle que nous ne pensions pas possible.*

*Il est un détail de l'ameublement spécial qui, inseré dans la cuisine ou le salon, plutôt que dans la salle à manger d'un restaurant ou d'un hôtel, ne peut passer inaperçu.*



## ALLESTIMENTO BOTTIGLIE VERTICALI

Vertical bottles accomodation • Logement bouteilles en vertical

QV-OPT-BV



Sui modelli QV30 e QV40 è possibile richiedere l'optional allestimento bottiglie verticali. Durante la fase finale di costruzione vengono rimossi i tondini portabottiglie e sostituiti con degli appositi tappi affinché sia sempre possibile ripristinare l'allestimento standard con bottiglie orizzontali.

Con questa soluzione si può utilizzare il Quadro Vino anche per il servizio al bicchiere in quanto è possibile inserire e mantenere a giusta temperatura anche le bottiglie già aperte.

*Models QV30 and QV40 feature a vertical bottle fitting option. During the final phase of construction, support rods are removed and replaced with caps so that you can always restore the standard configuration with horizontal bottles.*

*With this solution you can use the QUADRO VINO for the service by the glass as you can set and maintain the right temperature even for open bottles.*

*Sur les modèles QV30 et QV40 il est possible avoir sur demande l'option de logement vertical des bouteilles. Pendant la phase finale de construction les tiges sont supprimés et remplacés par des bouchons appropriés de sorte que vous pouvez toujours restaurer la configuration standard avec des bouteilles horizontales.*

*Avec cette solution, vous pouvez utiliser le QUADRO VINO pour le service du vin au verre car vous pouvez saisir et de maintenir la bonne température, même les bouteilles ouvertes.*

# Quadro Vino

Il Quadro Vino permette di conservare e servire vini diversi alla giusta temperatura. La refrigerazione è ottenuta con un silenzioso impianto termoelettrico dal consumo molto limitato. La minima profondità consente l'installazione anche in spazi molto ridotti.

Il Quadro Vino ha un impianto di refrigerazione ecologico privo di gas inquinanti ed è costruito con materiali riciclabili. La sostituzione dei componenti è semplice e rende sempre conveniente la riparazione del prodotto.

*Quadro Vino allows you to preserve and serve different wines at the right temperature. Refrigeration is achieved thanks to a silent thermoelectrical system with very low consumption. Its minimal depth allows for installation even in small spaces.*

*Quadro Vino employs a green refrigeration system polluting gas-free and is made with recyclable materials. Replacement of spare parts is easy and therefore product maintenance is convenient.*

*Quadro Vino permet de stocker et servir différents vins à la correcte température. La réfrigération est obtenue par un système thermoélectrique silencieux à la consommation d'énergie très faible. La profondeur réduite permet une installation dans des petits espaces.*

*Quadro Vino dispose d'un système de réfrigération écologique sans la présence de gaz polluant et il est fabriqué avec des matériaux recyclables. Le remplacement des composants est simple et rend toujours économiquement la réparation du produit.*

## CARATTERISTICHE TECNICHE

Specifications • Caracteristiques techniques

Struttura in metallo

Struttura porta in alluminio

Cornice in legno / hpl / MDF

Vetrocamera 20 mm

Guarnizione magnetica

Pannello interno in acciaio

Illuminazione a LED bianco naturale  
4000 K - 30 led/mt - 7,2 W / mt - 572 lumen / mt

Impianto termoelettrico

Sbrinamento automatico

Refrigerazione ventilata

Sistema di antivibrazione

*Metal structure*

*Aluminum door structure*

*Wood / HPL / MDF door frame*

*20 mm double glazing*

*Magnetic gasket*

*Internal steel panel*

*White natural daylight LED  
4000 K - 30 led/mt - 7,2 W / mt - 572 lumen / mt*

*Thermoelectric system*

*Automatic defrosting*

*Ventilated refrigeration*

*Anti-vibration system*

*Structure métallique*

*Structure porte en aluminium*

*Cadre en bois / HPL / MDF*

*Double vitrage 20 mm*

*Joint magnétique*

*Panneau interne en acier*

*LED blanc day-light naturel  
4000 K - 30 led/mt - 7,2 W / mt - 572 lumen / mt*

*Système thermoélectrique*

*Dégivrage automatique*

*Réfrigération ventilée*

*Système anti-vibration*

## CONFIGURATORE ONLINE

Online builder • Outil de configuration en ligne



MODELLO • MODEL • MODÈLE



QV12



QV30



QV40



QV52

1 - STRUTTURA • STRUCTURE • STRUCTURE



**RAL 9010**  
bianco  
white  
blanche  
B



**RAL 9005**  
nero  
black  
noir  
N

2 - CORNICI • FRAMES • CADRES

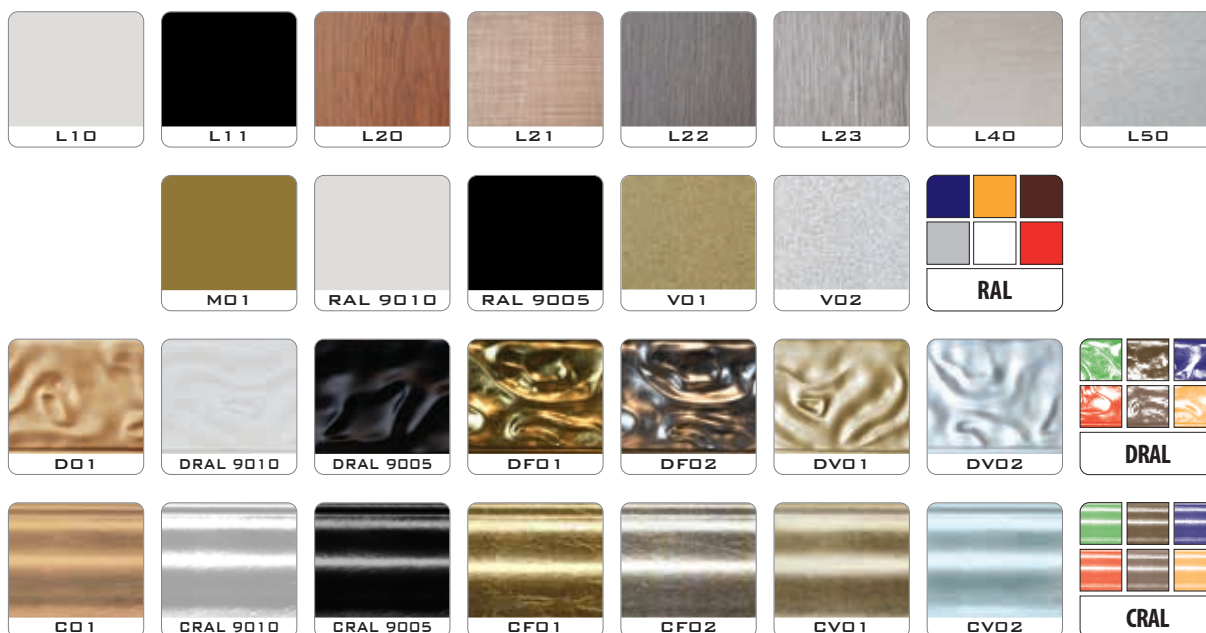

3 - PANNELLI • PANELS • PANNEAUX



COLORE LUCE • LIGHT COLOUR • COLORIS LUMIÈRE

**Standard**  
○○○  
LED bianco naturale  
white natural daylight LED  
LED blanc day-light naturel

**Optional**  
●●●  
LED blu  
blue LED  
LED bleu

OPT-QLB



HPL laminato alta pressione • High pressure laminate • Stratifiés haute pression



● **LD1**

HPL non verniciato  
no finish HPL  
HPL non peinte

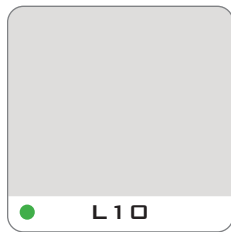

● **L10**

bianco opaco  
matt white  
blanc mat

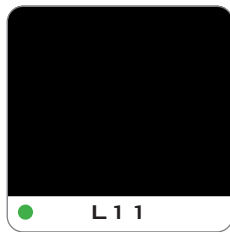

● **L11**

nero opaco  
matt black  
noir mat

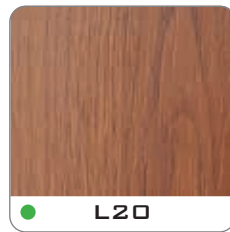

● **L20**

castagno  
chestnut  
chêne



● **L21**

teak roble  
teak roble  
teck rouvre



● **L22**

wengé loft  
loft wenge  
wenge loft



● **L23**

larice cenere  
ash Larch  
mélèze cendre



● **L40**

cemento tortora  
dove concrete  
ciment taupe

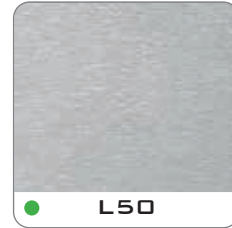

● **L50**

acciaio satinato  
satin-finish steel  
acier satiné

MDF non verniciato • No finish MDF • MDF non peinte



● **MD1**

MDF non verniciato  
no finish MDF  
MDF non peinte

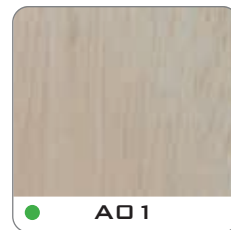

● **AO1**

ayous non verniciato  
no finish ayous  
ayous non peinte

Rivestimento in foglia • Leaf finish • Revêtement en feuille métallique

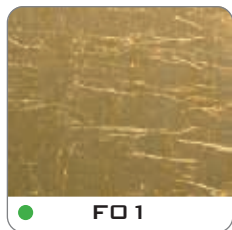

● **FO1**

oro patinato  
gold coated  
revêtement or



● **FO2**

argento patinato  
silver coated  
revêtement argent

Verniciatura a liquido • Liquid paint finish • Laquage par peinture liquide

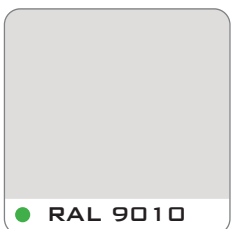

● **RAL 9010**

bianco opaco (20 gloss)  
matt white (20 gloss)  
blanc mat (20 gloss)

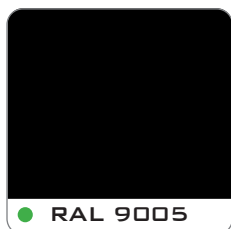

● **RAL 9005**

nero opaco (20 gloss)  
matt black (20 gloss)  
noir mat (20 gloss)

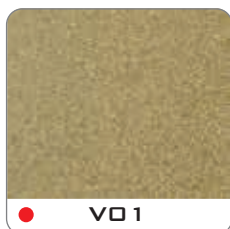

● **VO1**

verniciato oro  
gold painted  
peinture or



● **VO2**

verniciato argento  
silver painted  
peinture argent



● **RAL 20/100**

opaco 20 gloss - lucido 100 gloss  
matte 20 gloss - polished 100 gloss  
mat 20 gloss - brillant 100 gloss

Verniciatura a liquido (Dune) • Liquid paint finish (Dune) • Laquage par peinture liquide (Dune)



● DRAL 9010

bianco opaco (20 gloss)  
*matte white (20 gloss)*  
*blanc mat (20 gloss)*

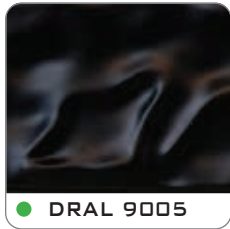

● DRAL 9005

nero opaco (20 gloss)  
*matte black (20 gloss)*  
*noir mat (20 gloss)*



● DVO 1

verniciato oro  
*gold painted*  
*peinture or*



● DVO 2

verniciato argento  
*silver painted*  
*peinture argent*

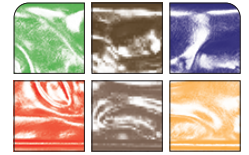

● DRAL 20/100

opaco 20 gloss - lucido 100 gloss  
 matte 20 gloss - polished 100 gloss  
 mat 20 gloss - brillant 100 gloss

Dune non verniciato • Dune no finish • Dune non peinte



● D01

Dune non verniciato  
*Dune no finish*  
*Dune non peinte*



● DFO 1

oro patinato  
*gold coated*  
*revêtement or*



● DFO 2

argento patinato  
*silver coated*  
*revêtement argent*

Verniciatura a liquido (Classica) • Liquid paint finish (Classic) • Laquage par peinture liquide (Classique)



CRAL 9010

bianco opaco (20 gloss)  
*matte white (20 gloss)*  
*blanc mat (20 gloss)*



CRAL 9005

nero opaco (20 gloss)  
*matte black (20 gloss)*  
*noir mat (20 gloss)*



CVO 1

verniciato oro  
*gold paint*  
*peinture or*



CVO 2

verniciato argento  
*silver paint*  
*peinture argent*

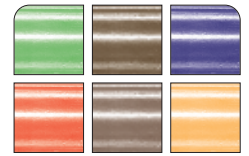

CRAL 20/100

opaco 20 gloss - lucido 100 gloss  
 matte 20 gloss - glossy 100 gloss  
 mat 20 gloss - brillant 100 gloss

Classica non verniciata • No finish Classic • Classique non peint



C01

Classica non verniciata  
*no finish Classic*  
*Classique non peint*



CFO 1

oro patinato  
*gold coated*  
*revêtement or*



CFO 2

argento patinato  
*silver coated*  
*revêtement argent*

Rivestimento in foglia (Classica) • Leaf finish (Classic)

Ecopelle • Faux leather • Éco-cuir

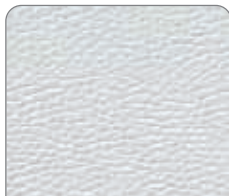

**E 10**

ecopelle bianca  
white faux leather  
éco-cuir blanc

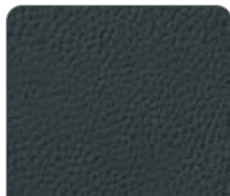

**E 11**

ecopelle nera  
black faux leather  
éco-cuir noir

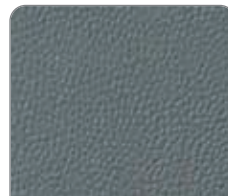

**E 12**

ecopelle grigia  
grey faux leather  
éco-cuir gris

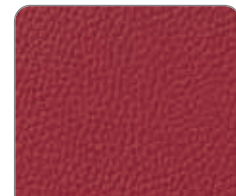

**E 13**

ecopelle rossa  
red faux leather  
éco-cuir rouge

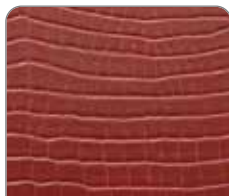

**E 39**

ecopelle pitone rosso  
red python faux leather  
éco-cuir python rouge

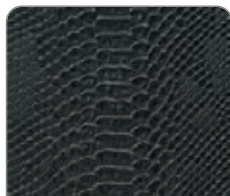

**E 40**

ecopelle rettile nera  
black faux reptile leather  
éco-cuir reptile noir



**E 41**

ecopelle rettile blu  
blue faux reptile leather  
éco-cuir reptile bleu



**E 50**

ecopelle intrecciata tabacco  
tobacco woven faux leather  
éco-cuir tissé tabac

Sughero • Cork • Liège

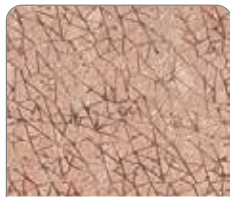

**E 30**

sughero rete  
cork mesh  
liège filet



**E 31**

sughero spina di pesce  
cork herringbone  
liège chevrons



Laminato • Laminate • Stratifié



**T02**  
grigio monzone  
gray monsoon  
gris mousson

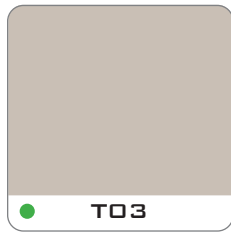

**T03**  
sabbia creola  
creole sand  
sable créole



**T04**  
blu avio  
airforce blue  
bleu aviation

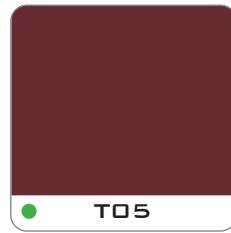

**T05**  
rosso mattone  
red brick  
brique



**T20**  
rame spazzolato  
brushed copper  
cuivre satiné



**T21**  
rame acidato  
acid washed copper  
cuivre traité à l'acide

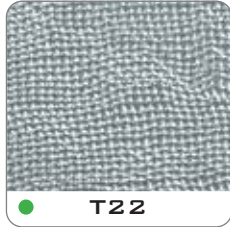

**T22**  
argento lux  
silver lux  
argent lux



**T23**  
bronzo lux  
bronze lux  
bronze lux

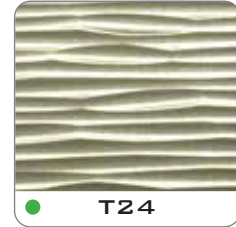

**T24**  
oro onde  
gold wave  
vague d'or

MDF verniciato • Lacquered MDF • MDF laqué



**M02**  
ciliegio  
cherry  
merisier



**M03**  
wengé  
wengé  
wengé

## Colorazioni speciali RAL

Special RAL colors

 <p><b>RAL 1001</b> BEIGE</p>	 <p><b>RAL 1002</b> SAND YELLOW</p>	 <p><b>RAL 1003</b> SIGNAL YELLOW</p>	 <p><b>RAL 1006</b> MAIZE YELLOW</p>	 <p><b>RAL 1007</b> DAFFODIL YELLOW</p>
 <p><b>RAL 1011</b> BROWN BEIGE</p>	 <p><b>RAL 1014</b> IVORY</p>	 <p><b>RAL 1015</b> LIGHT IVORY</p>	 <p><b>RAL 1019</b> GREY BEIGE</p>	 <p><b>RAL 1024</b> OCHRE YELLOW</p>
 <p><b>RAL 1034</b> PASTEL YELLOW</p>	 <p><b>RAL 2000</b> YELLOW ORANGE</p>	 <p><b>RAL 2003</b> PASTEL ORANGE</p>	 <p><b>RAL 2010</b> SIGNAL ORANGE</p>	 <p><b>RAL 3004</b> PURPLE RED</p>
 <p><b>RAL 3005</b> WINE RED</p>	 <p><b>RAL 3007</b> BLACH RED</p>	 <p><b>RAL 3009</b> OXIDE RED</p>	 <p><b>RAL 3012</b> BEIGE RED</p>	 <p><b>RAL 3017</b> ROSE</p>
 <p><b>RAL 3031</b> ORIENT RED</p>	 <p><b>RAL 4001</b> RED LILAC</p>	 <p><b>RAL 4004</b> CLARET VIOLET</p>	 <p><b>RAL 4009</b> PASTEL VIOLET</p>	 <p><b>RAL 5003</b> SAPPHIRE BLUE</p>
 <p><b>RAL 5004</b> BLACK BLUE</p>	 <p><b>RAL 5005</b> SIGNAL BLUE</p>	 <p><b>RAL 5008</b> GREY BLUE</p>	 <p><b>RAL 5012</b> LIGHT BLUE</p>	 <p><b>RAL 5014</b> PIGEON BLUE</p>

 <b>RAL 5020</b> OCEAN BLUE	 <b>RAL 6005</b> MOSS GREEN	 <b>RAL 6011</b> RESEDA GREEN	 <b>RAL 6019</b> PASTEL GREEN	 <b>RAL 7000</b> SQUIRREL GREY
 <b>RAL 7001</b> SILVER GREY	 <b>RAL 7003</b> MOSS GREY	 <b>RAL 7004</b> SIGNAL GREY	 <b>RAL 7006</b> BEIGE GREY	 <b>RAL 7011</b> IRON GREY
 <b>RAL 7030</b> STONE GREY	 <b>RAL 7032</b> PEBBLE GREY	 <b>RAL 7035</b> LIGHT GREY	 <b>RAL 7036</b> PLATINUM GREY	 <b>RAL 7042</b> TRAFFIC GREY A
 <b>RAL 8002</b> SIGNAL BROWN	 <b>RAL 8007</b> FAWN BROWN	 <b>RAL 8014</b> SEPIA BROWN	 <b>RAL 8017</b> CHOCOLATE BROWN	 <b>RAL 8019</b> GREY BROWN
 <b>RAL 8022</b> BLACK BROWN	 <b>RAL 8025</b> PALE BROWN	 <b>RAL 8028</b> TERRA BROWN	 <b>RAL 9001</b> CREAM	 <b>RAL 9002</b> GREY WHITE
 <b>RAL 9003</b> SIGNAL WHITE	 <b>RAL 9004</b> SIGNAL BLACK	 <b>RAL 9005</b> JET BLACK	 <b>RAL 9010</b> PURE WHITE	 <b>RAL 9016</b> TRAFFIC WHITE

I colori stampati in questa cartella sono indicativi  
*The colours printed and shown in this folder are merely indicative*  
*Les coloris imprimés ici sont indicatifs*



# Legenda





























## LEGEND



## LÉGENDE



CODE	Codice	Code	Code
	Temperatura (Temperatura ambiente 25 °C - Umidità relativa 50%)	Temperature (Ambient temperature 25°C - Relative humidity 50%)	Température (Température ambiante 25°C - Humidité relative 50%)
	Umidità (Temperatura ambiente 25 °C - Umidità relativa 50%)	Humidity (Ambient temperature 25°C - Relative humidity 50%)	Humidité (Température ambiante 25°C - Humidité relative 50%)
	Versione	Version	Version
	Refrigerato	Cooled	Réfrigéré
	Neutro	Neutral	Neutre
	Piastr e eutettiche	Eutectic plates	Plaques eutectiques
	Riscaldato	Heated	Chauffant
	Ventilato	Ventilated	Ventilé
	Ventole interne spente	Internal fans off	Ventilation interne désactivée
	Ventole interne accese	Internal fans on	Ventilation interne activée
	Rumorosità	Noise level	Bruyance
	Tensione	Voltage	Tension
	Assorbimento	Absorption	Absorption
<b>Class</b>	Classe energetica	Energy class	Classe énergétique
	Modello compressore	Compressor type	Modèle du compresseur
<b>HFC</b>	Gas refrigerante	Refrigerant gas	Gaz réfrigérant
	Quantità gas	Gas amount	Quantité de gaz
	Numero piastr e eutettiche	Number of eutectic plates	Nombre de plaques eutectiques
<b>LIGHT</b>	Luce	Light	Lumière
	Led bianco naturale (4000 K - 30 led/mt - 7,2 W / mt - 572 lumen / mt)	White natural daylight LED (4000 K - 30 led/mt - 7,2 W / mt - 572 lumen / mt)	LED blanc day-light naturel (4000 K - 30 led/mt - 7,2 W / mt - 572 lumen / mt)
	Led bianco caldo (3000 K - 60 led/mt - 14,4 W / mt - 900 lumen / mt)	brightwhite warm LED (3000 K - 60 led/mt - 14,4 W / mt - 900 lumen / mt)	LED blanc chaud (3000 K - 60 led/mt - 14,4 W / mt - 900 lumen / mt)
	Led blu	Blue LED	LED bleue
	Controller RGB (30 led/mt - 7,2 W / mt - 550 lumen / mt)	RGB controller (30 led/mt - 7,2 W / mt - 550 lumen / mt)	Regulateur RGB (30 led/mt - 7,2 W / mt - 550 lumen / mt)
	Controller bianco dinamico (2700/6000 K - 140 led/mt - 19,2 W / mt - 2000 lumen / mt)	Dinamic white controller (2700/6000 K - 140 led/mt - 19,2 W / mt - 2000 lumen / mt)	Regulateur blanc dynamique (2700/6000 K - 140 led/mt - 19,2 W / mt - 2000 lumen / mt)
	Cornice lineare	Linear frame	Cadre linéaire
	Cornice Dune	Dune frame	Cadre Dune

	Finitura metallo	Metal finish	Finition métal
	Nikel satinato	Satin nickel	Nickel satiné
	Oro lucido	Glossy gold	Doré brillant
	Lato posteriore vetrina	Showcase back side	Face postérieure vitrine
	Ante in vetro	Glass doors	Porte en verre
	Pannello cieco	Blank panel	Panneau borgne
	Numero piani (base compresa)	Number of shelves (including base)	Nombre de tablettes (base comprise)
	Numero cassetti	Number of drawers	Nombre de tiroirs
	Numero ante	Number of doors	Nombre de portes
	Numero bottiglie	Number of bottles	Nombre de bouteilles
	Altezza / diametro bottiglie	Bottle height / diameter	Hauteur/ diamètre bouteilles
	Kit salumeria	Salami kit	Kit salaisons
	Colore spalla	Shoulder colour	Coloris côté
	Presente	Present	Présent
-	Assente / dato non disponibile	Absent / data not available	Absent / information non disponible
	Volume interno	Internal volume	Capacité intérieure
	Dimensioni nette	Net dimensions	Dimensions nettes
	Dimensioni con imballo	Dimensions including packaging	Dimensions avec emballage
	Dimensioni con imballo su pedana	Dimensions including packaging on pallet	Dimensions avec emballage sur palette
	Peso netto	Net weight	Poids net
	Peso con imballo	Weight with packaging	Poids avec emballage
	Peso con imballo su pedana	Weight with packaging on pallet	Poids avec emballage sur palette
	Volume con imballo	Volume with packaging	Volume avec emballage
	Volume con imballo su pedana	Volume with packaging on pallet	Volume avec emballage sur palette
	Imballo in legno	Wooden packaging	Emballage en bois
<b>DS</b>	Descrizione	Description	Description
	Dimensione ventola	Fan blade size	Dimension du ventilateur
	∅ mm - Connesioni (liquido - aspirazione)	∅ mm - Connections (liquid - suction)	∅ mm - Connexions (liquide - aspiration)